

4.3 Obrázky zadání

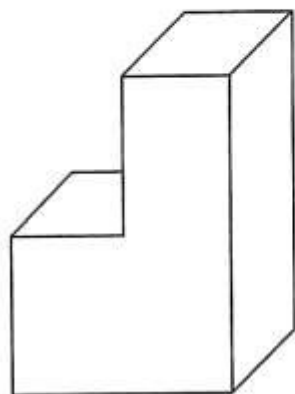

Obr. 4.14

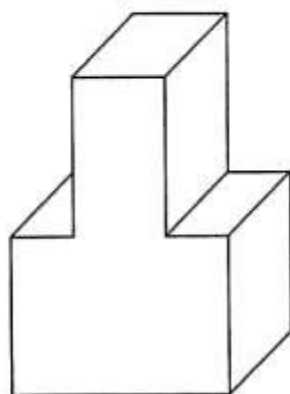

Obr. 4.15

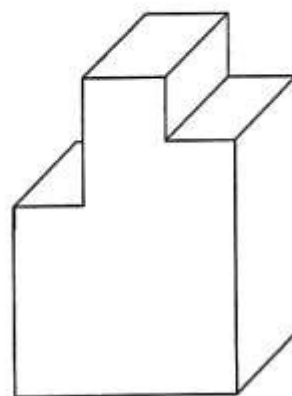

Obr. 4.16

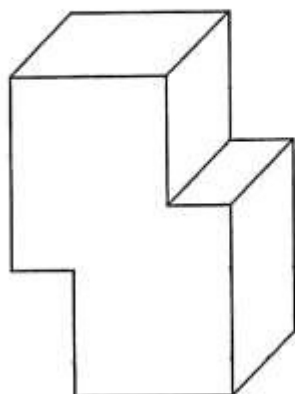

Obr. 4.17

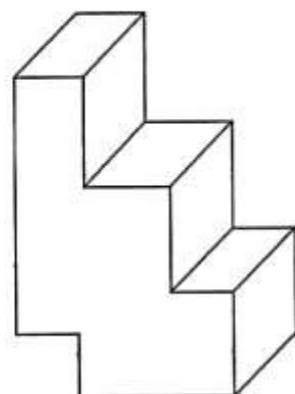

Obr. 4.18

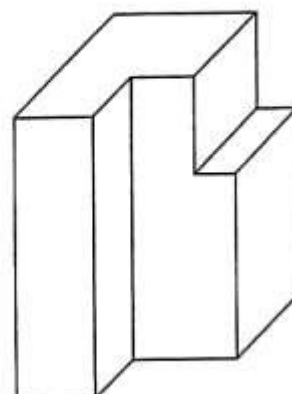

Obr. 4.19

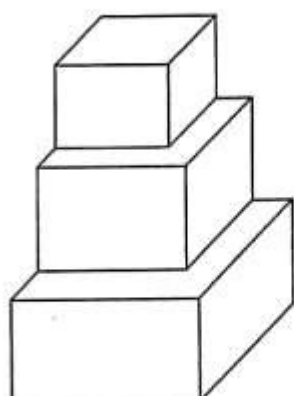

Obr. 4.20

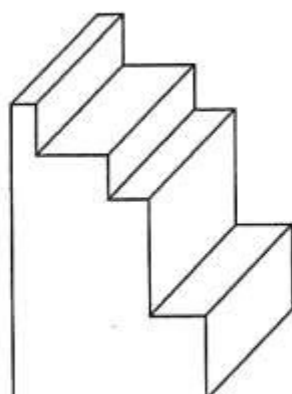

Obr. 4.21

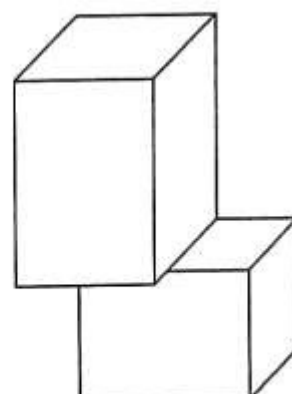

Obr. 4.22

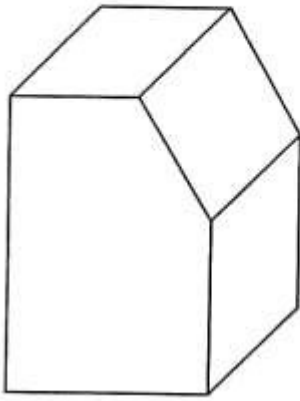

Obr. 4.23

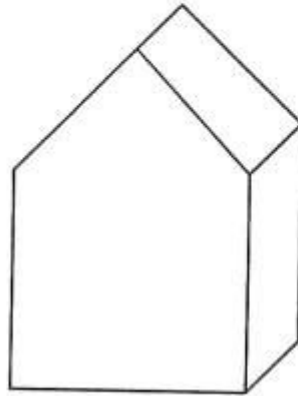

Obr. 4.24

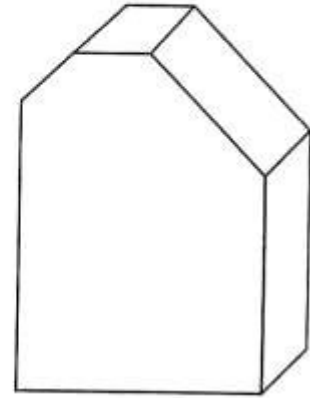

Obr. 4.25

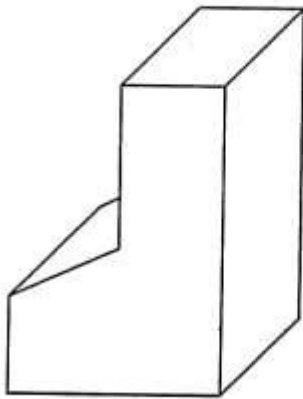

Obr. 4.26

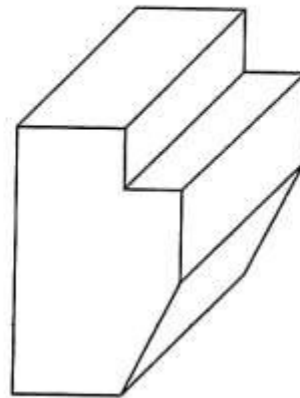

Obr. 4.27

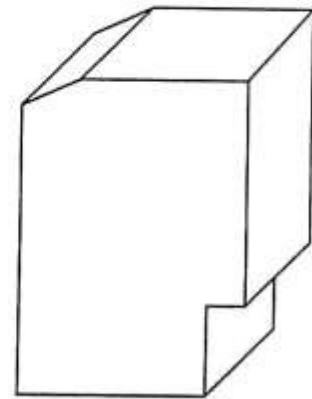

Obr. 4.28

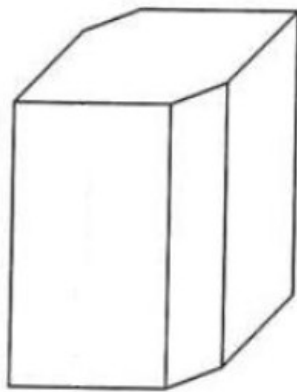

Obr. 4.29

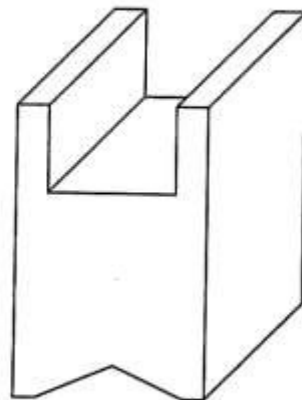

Obr. 4.30

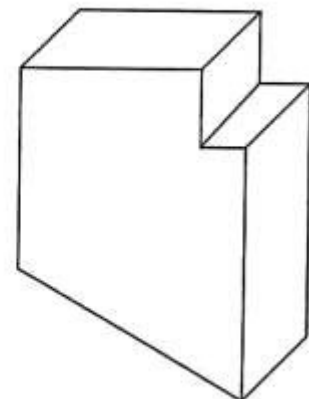

Obr. 4.31

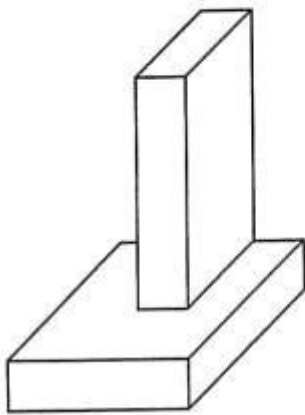

Obr. 4.32

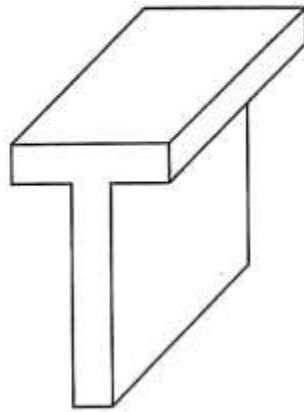

Obr. 4.33

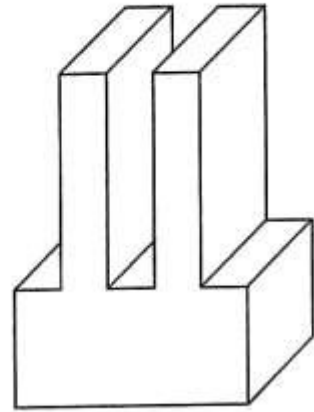

Obr. 4.34

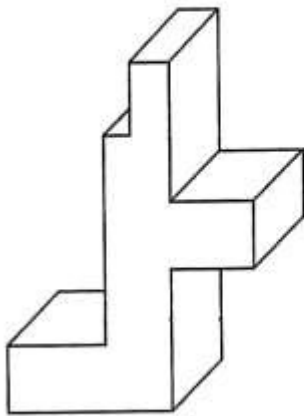

Obr. 4.35

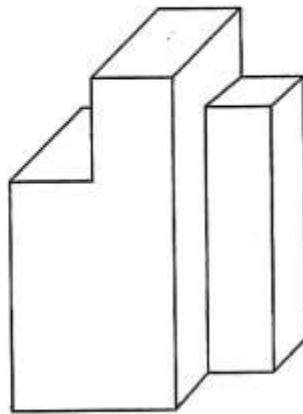

Obr. 4.36

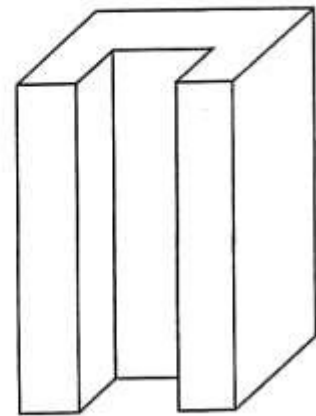

Obr. 4.37

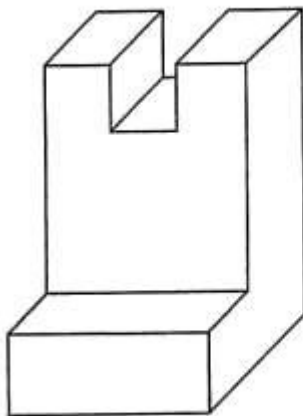

Obr. 4.38

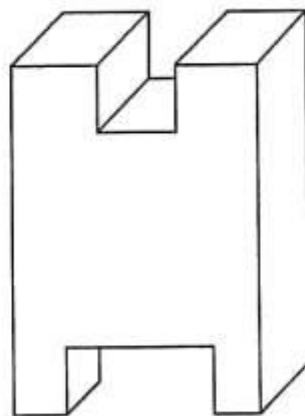

Obr. 4.39

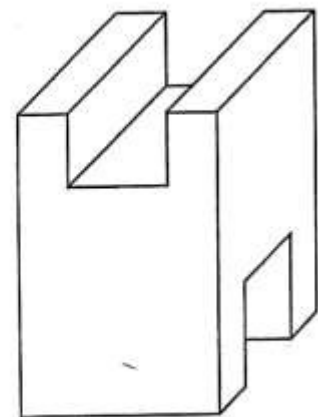

Obr. 4.40

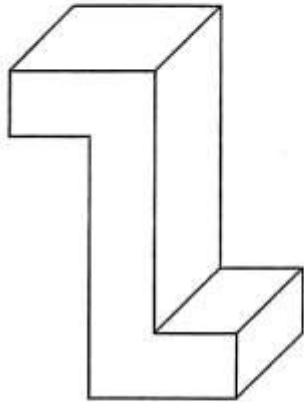

Obr. 4.41

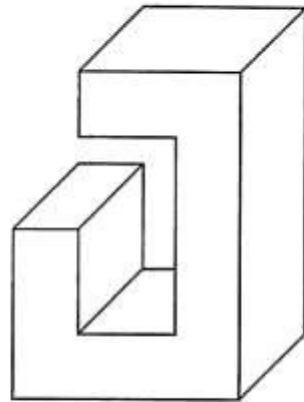

Obr. 4.42

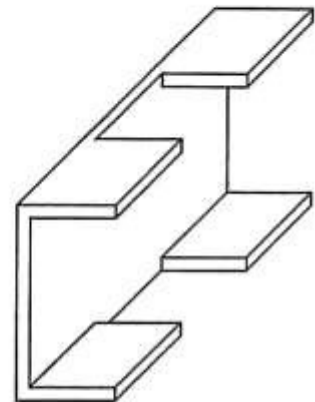

Obr. 4.43

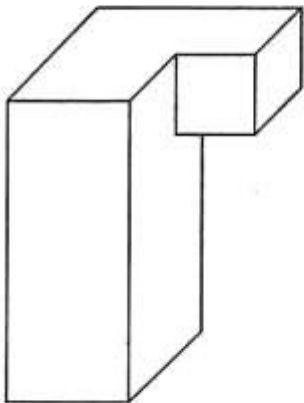

Obr. 4.44

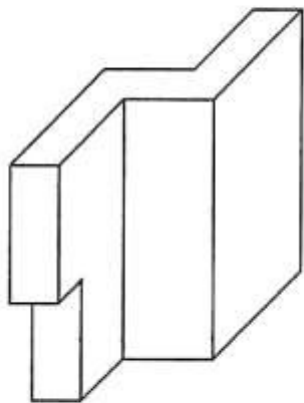

Obr. 4.45

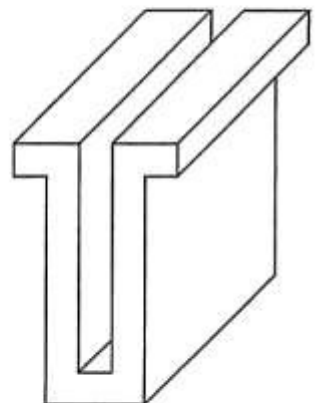

Obr. 4.46

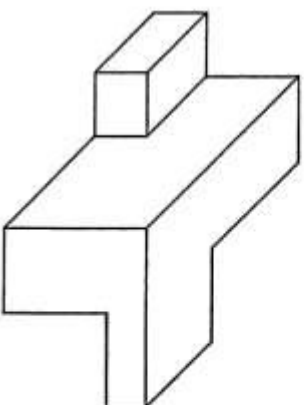

Obr. 4.47

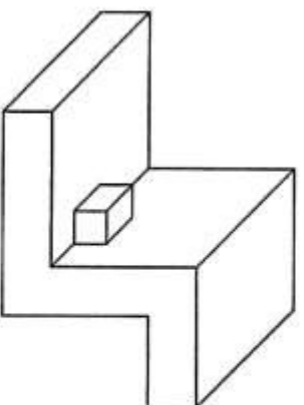

Obr. 4.48

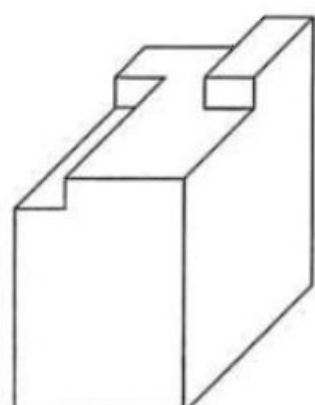

Obr. 4.49

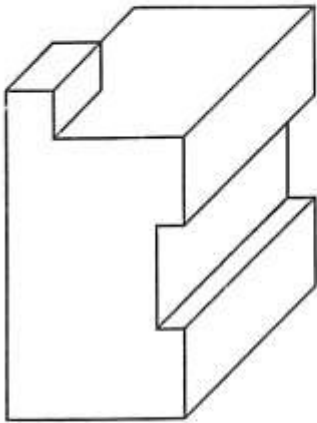

Obr. 4.50

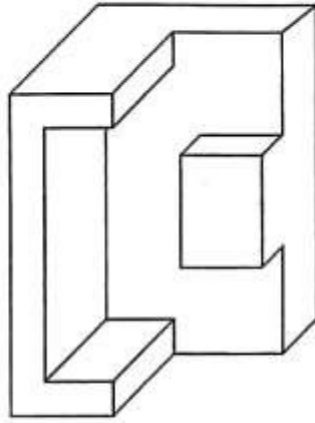

Obr. 4.51

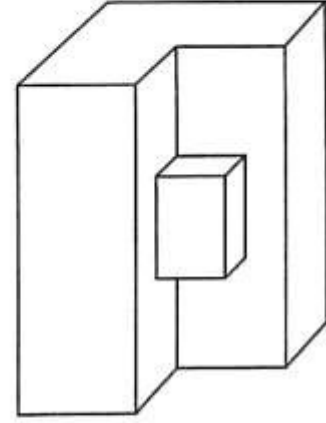

Obr. 4.52

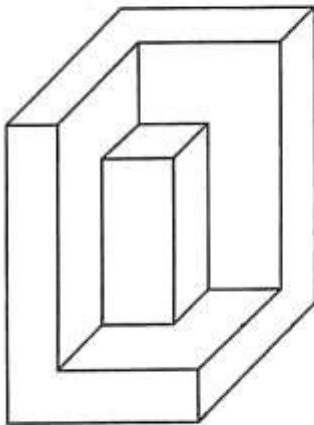

Obr. 4.53

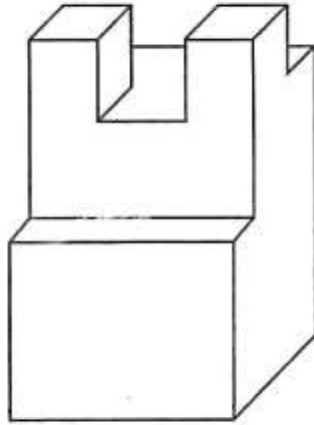

Obr. 4.54

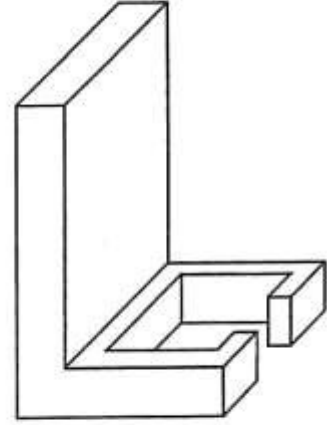

Obr. 4.55

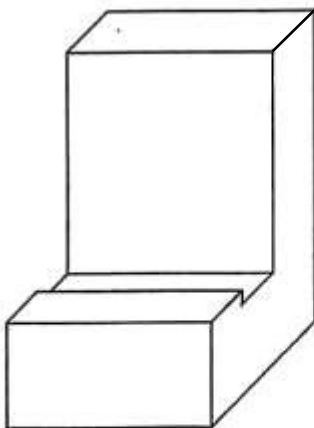

Obr. 4.56

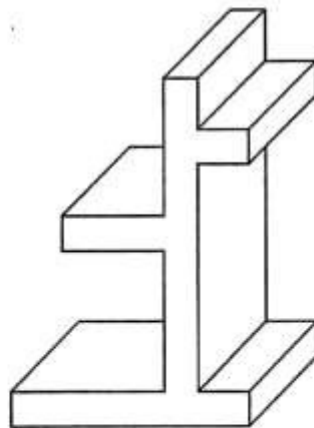

Obr. 4.57

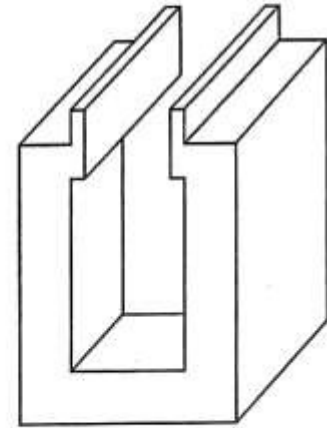

Obr. 4.58

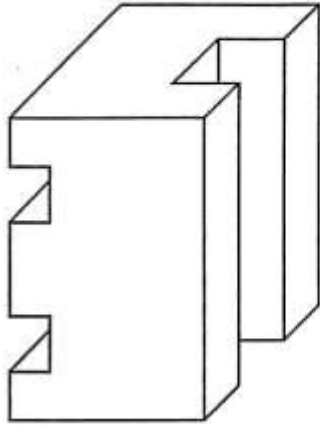

Obr. 4.59

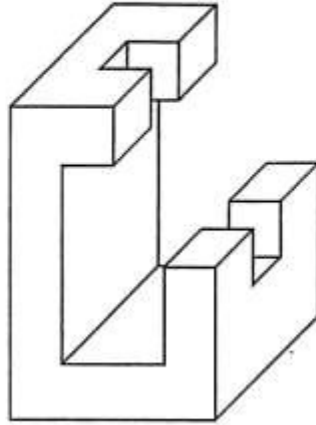

Obr. 4.60

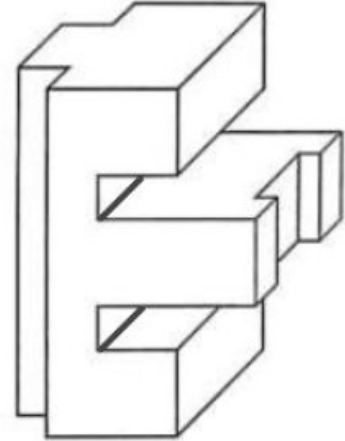

Obr. 4.61

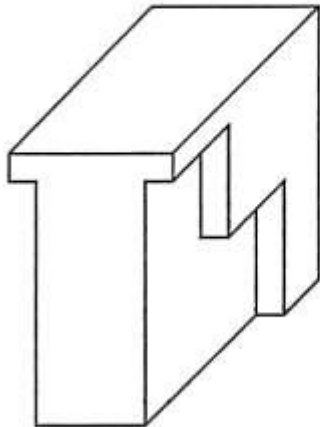

Obr. 4.62

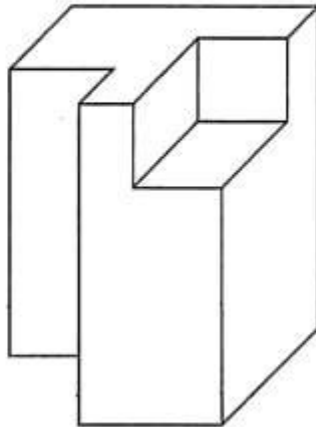

Obr. 4.63

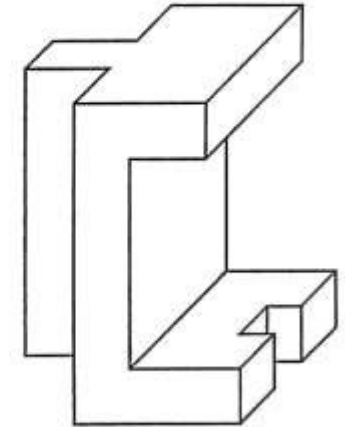

Obr. 4.64

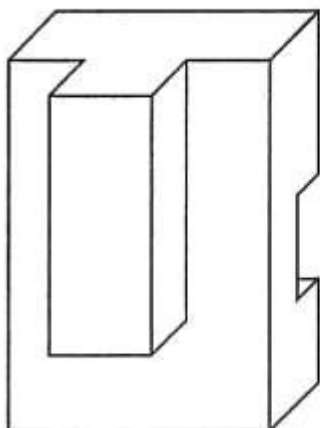

Obr. 4.65

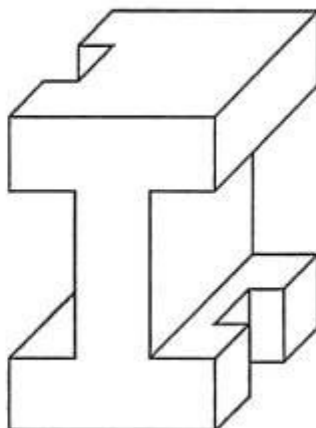

Obr. 4.66

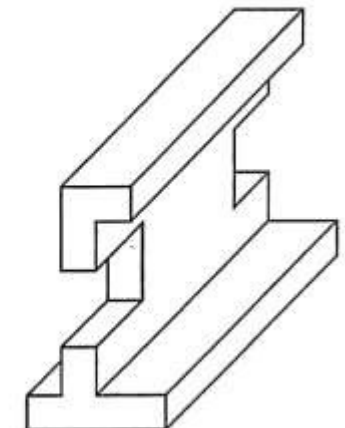

Obr. 4.67

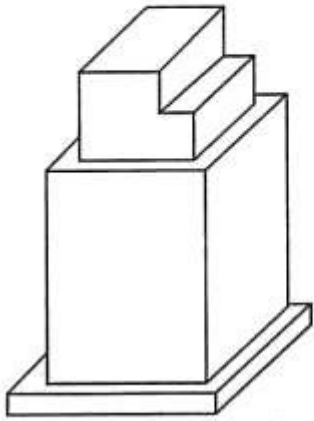

Obr. 4.68

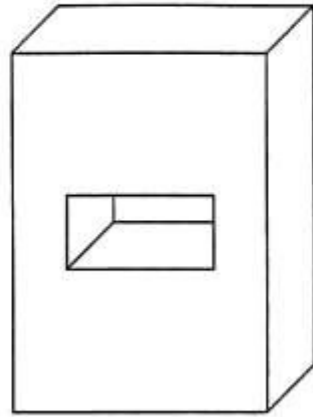

Obr. 4.69

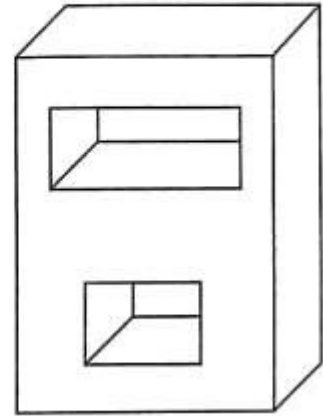

Obr. 4.70

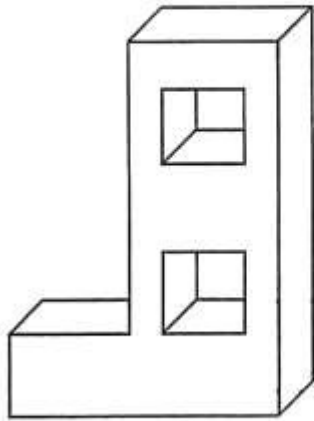

Obr. 4.71

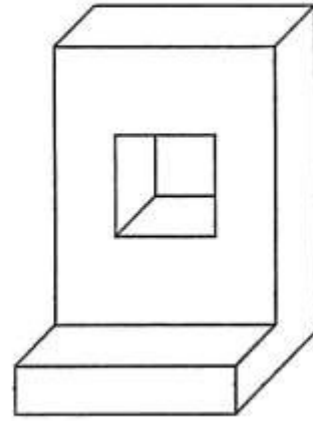

Obr. 4.72

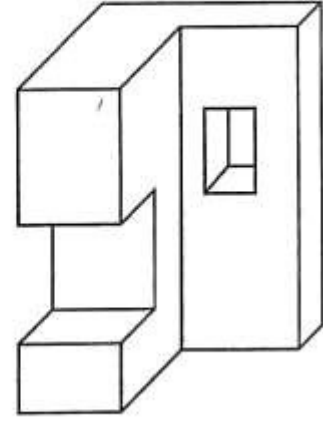

Obr. 4.73

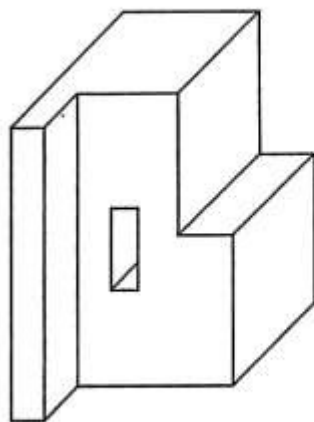

Obr. 4.74

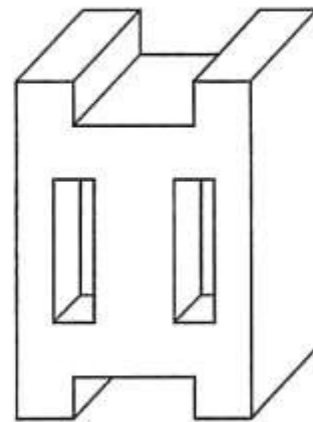

Obr. 4.75

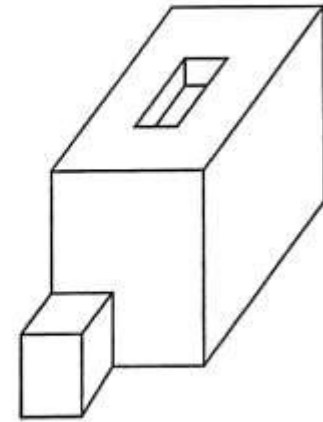

Obr. 4.76

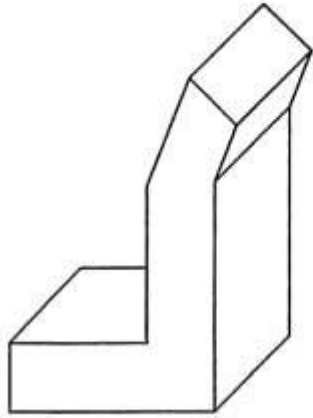

Obr. 4.77

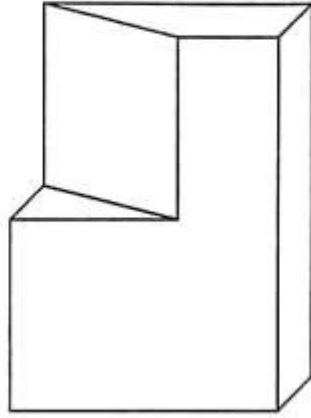

Obr. 4.78

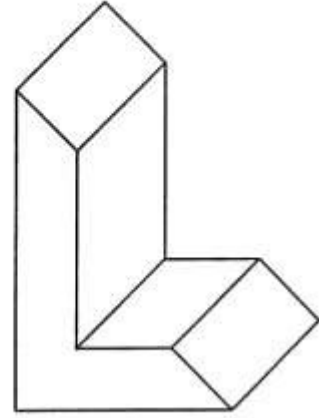

Obr. 4.79

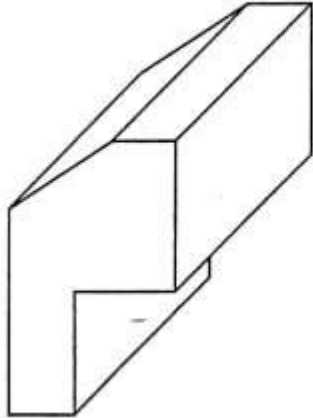

Obr. 4.80

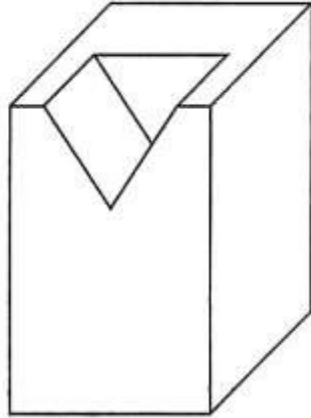

Obr. 4.81

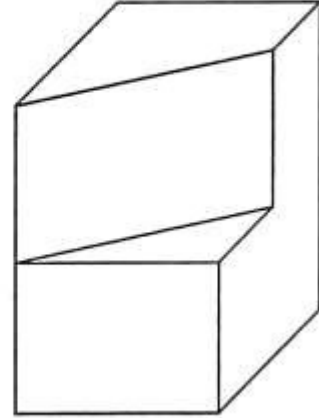

Obr. 4.82

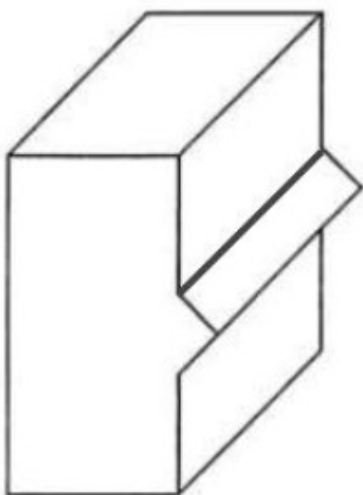

Obr. 4.83

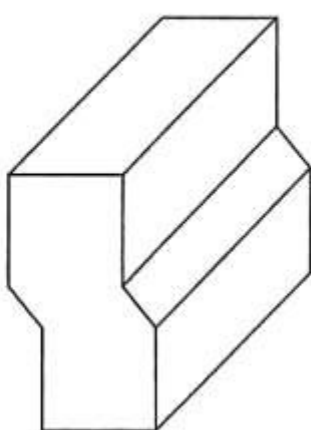

Obr. 4.84

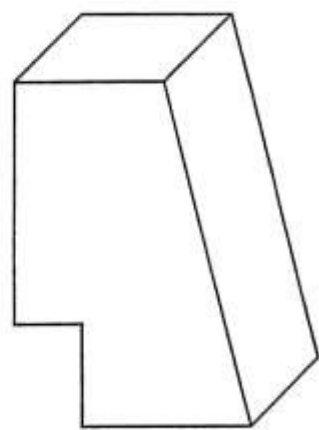

Obr. 4.85

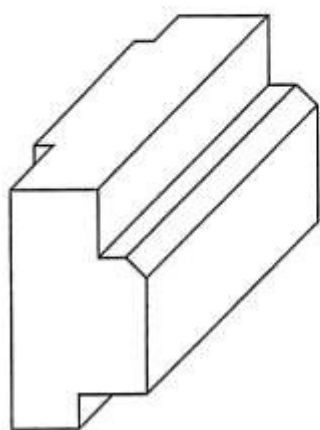

Obr. 4.86

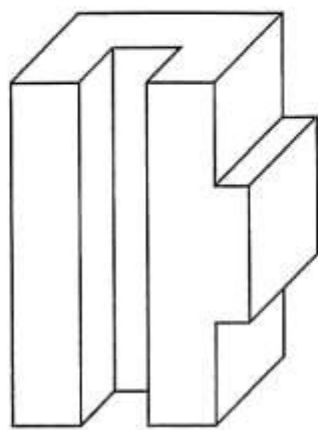

Obr. 4.87

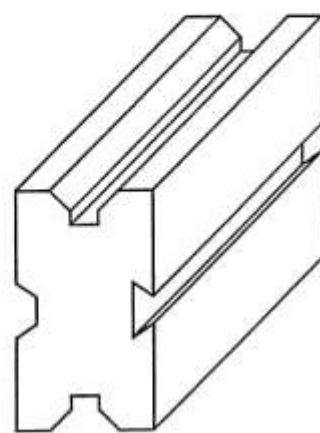

Obr. 4.88

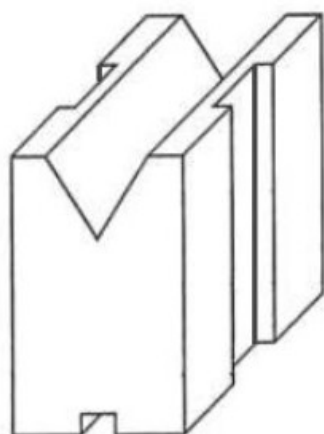

Obr. 4.89

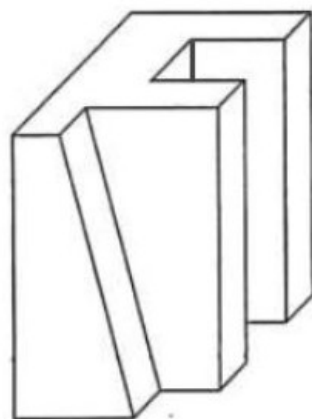

Obr. 4.90

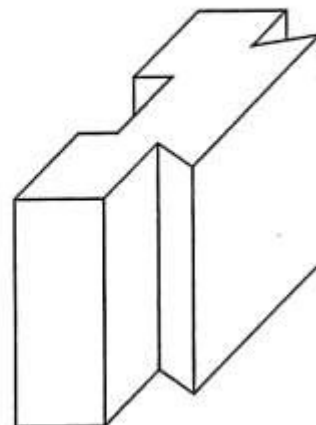

Obr. 4.91

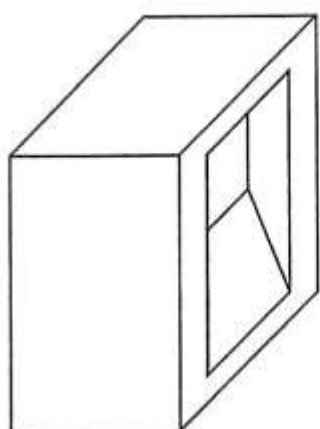

Obr. 4.92

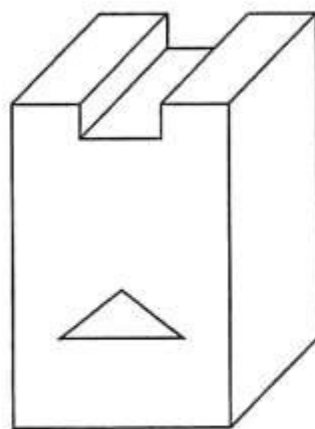

Obr. 4.93

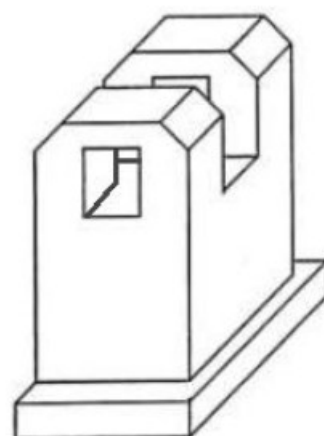

Obr. 4.94

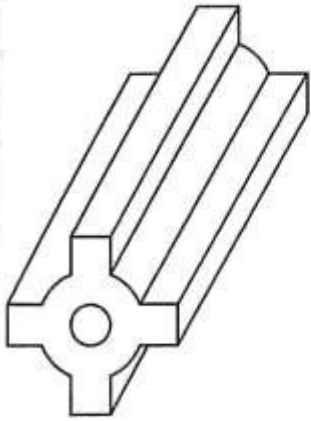

Obr. 4.95



Obr. 4.96

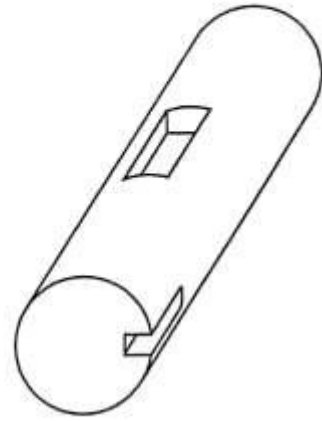

Obr. 4.97

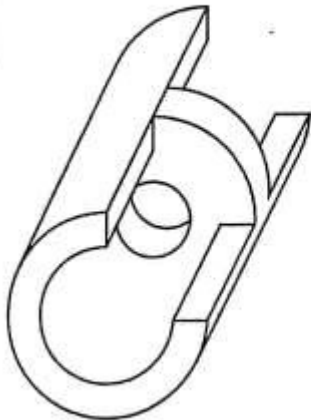

Obr. 4.98

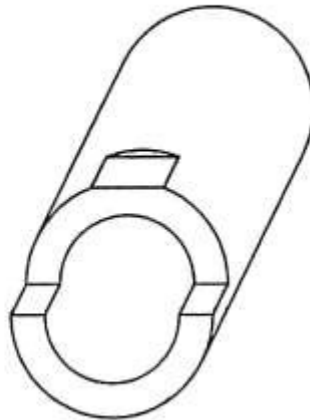

Obr. 9.99

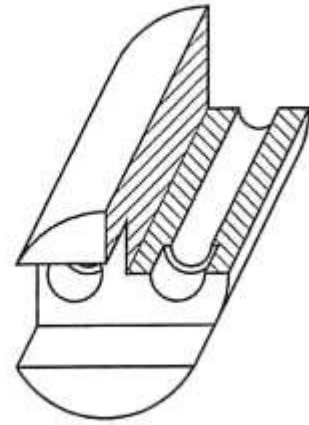

Obr. 4.100

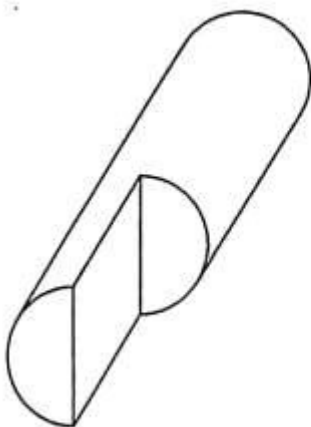

Obr. 4.101

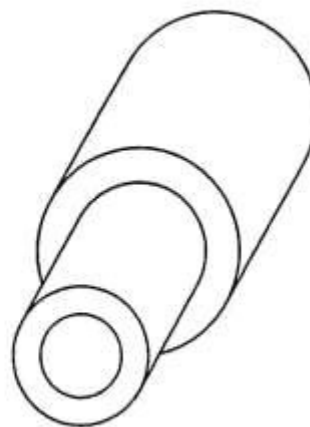

Obr. 4.102

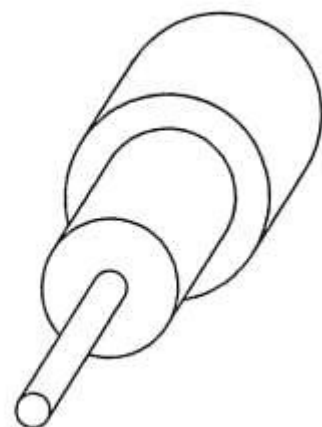

Obr. 4.103

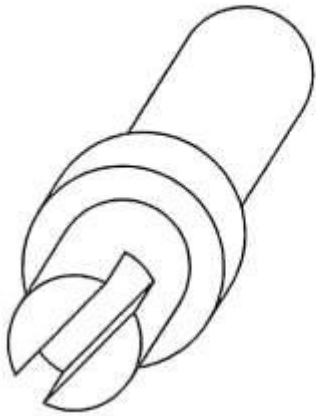

Obr. 4.104

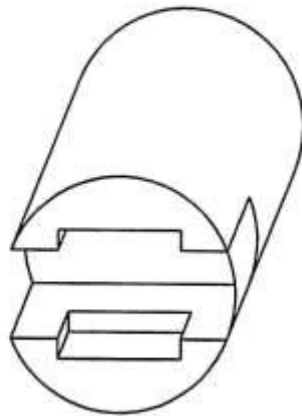

Obr. 4.105

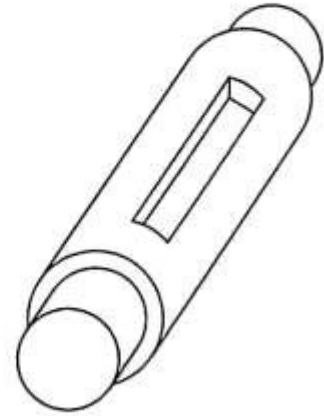

Obr. 4.106

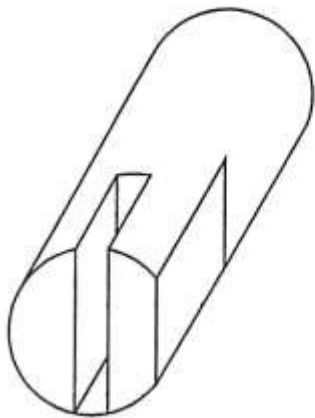

Obr. 4.107

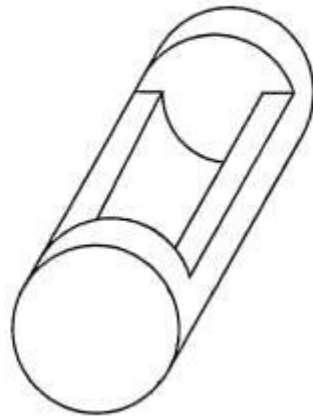

Obr. 4.108

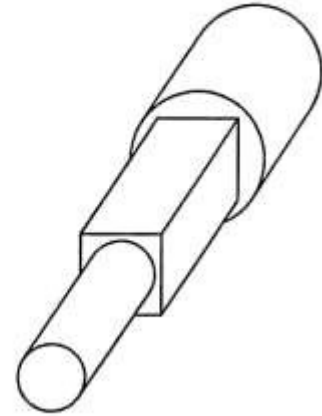

Obr. 4.109

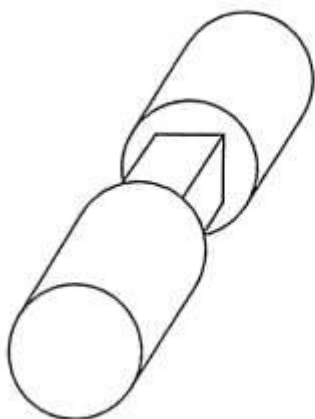

Obr. 4.110

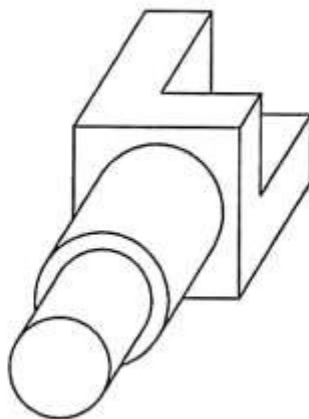

Obr. 4.111

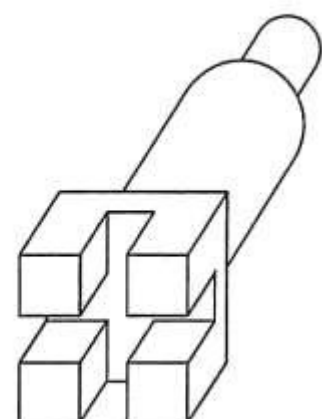

Obr. 4.112

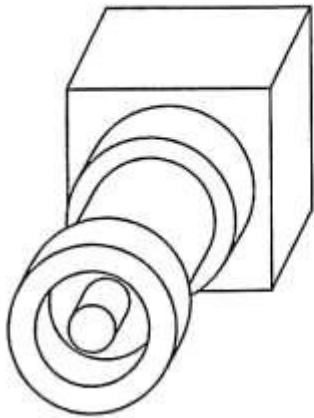

Obr. 4.113

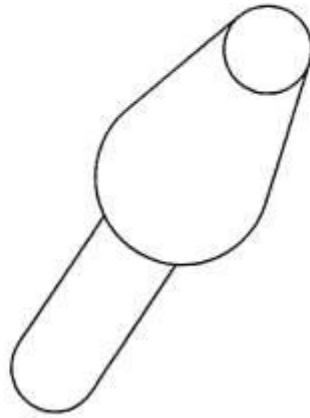

Obr. 4.114



Obr. 4.115

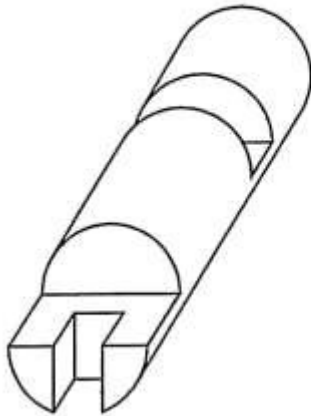

Obr. 4.116

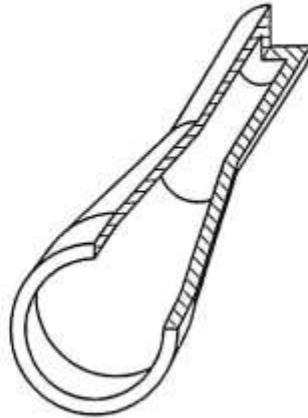

Obr. 4.117

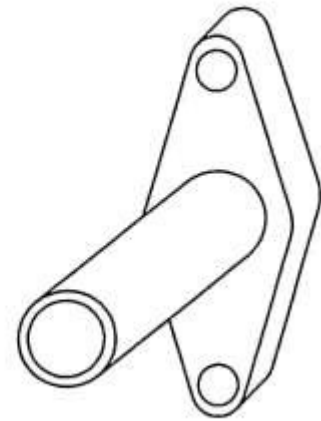

Obr. 4.118

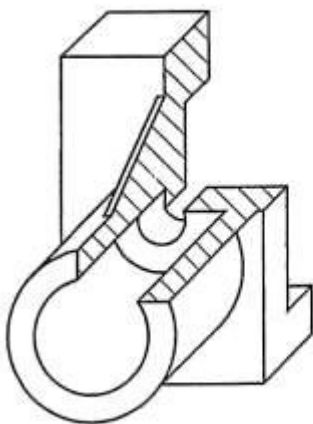

Obr. 4.119

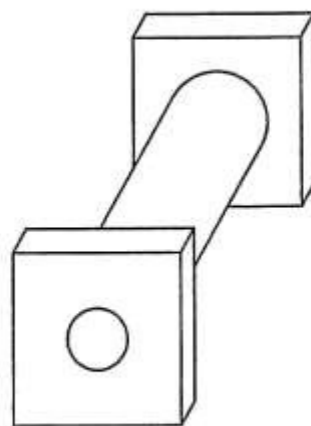

Obr. 4.120

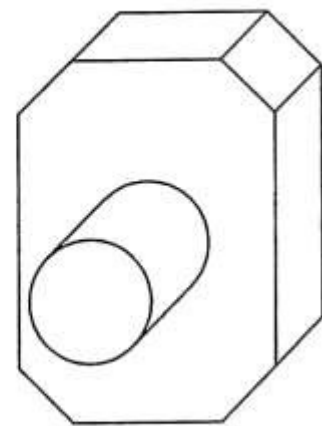

Obr. 4.121

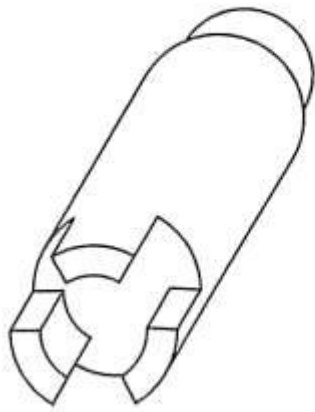

Obr. 4.122



Obr. 4.123

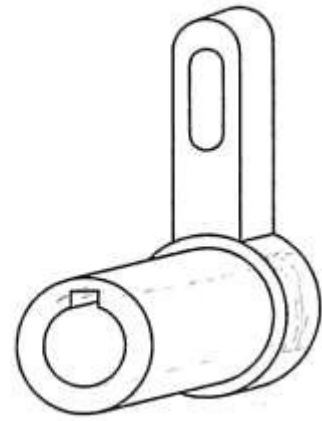

Obr. 4.124

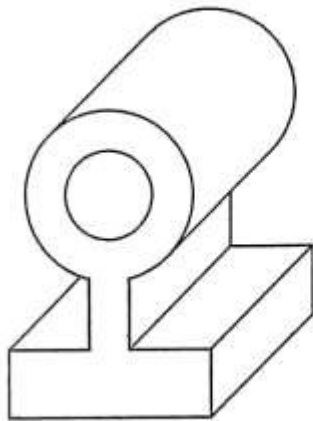

Obr. 4.125

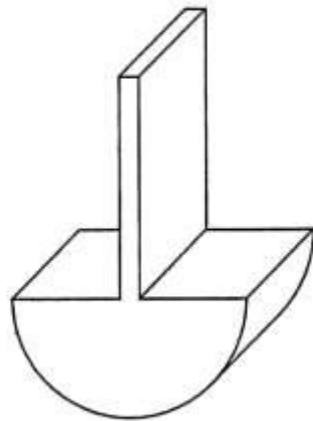

Obr. 4.126

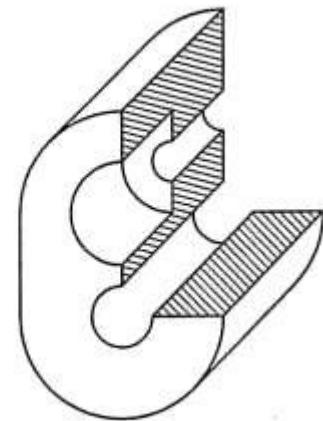

Obr. 4.127

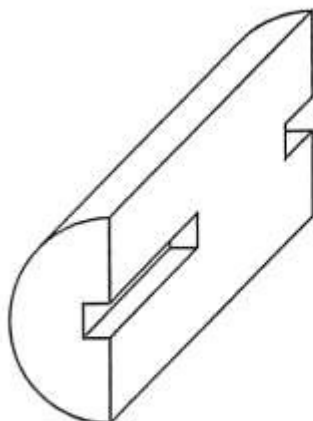

Obr. 4.128

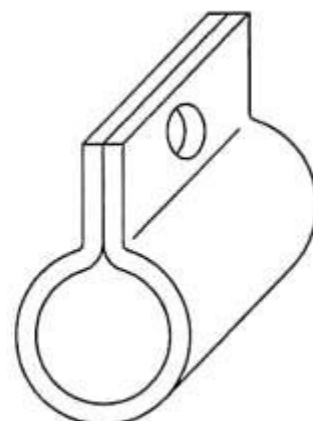

Obr. 4.129

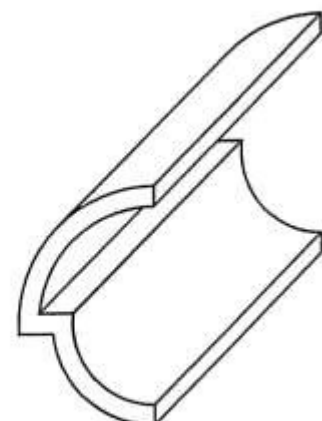

Obr. 4.130